

Lotus
Prestige M

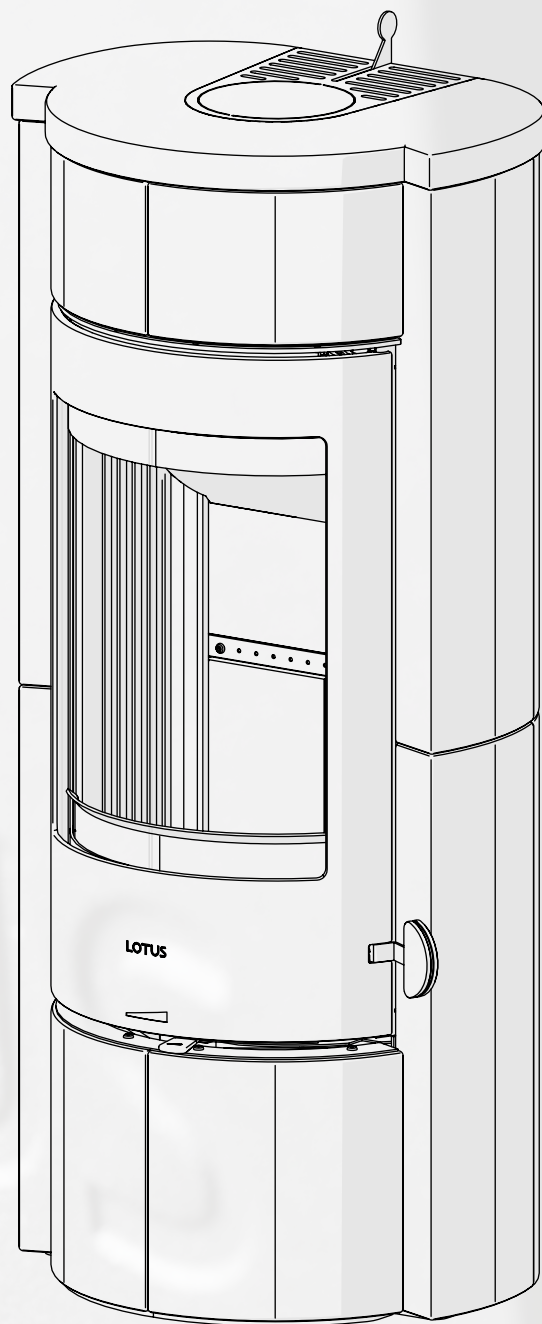

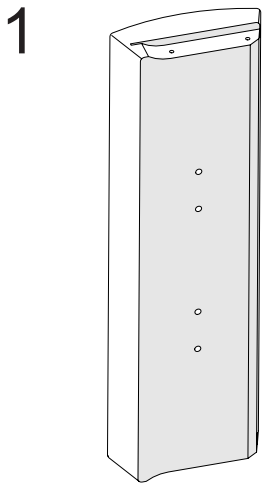

4x 88-500

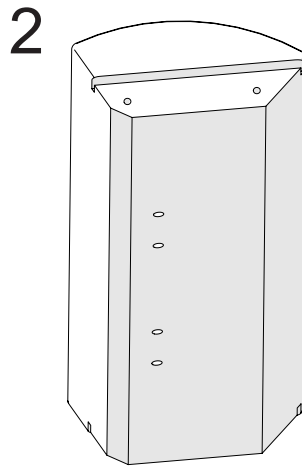

4x 88-502

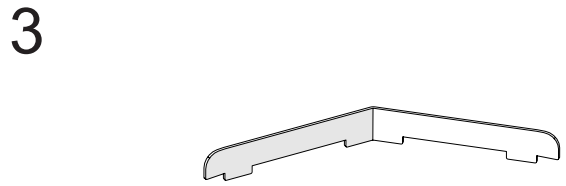

2x 88-208

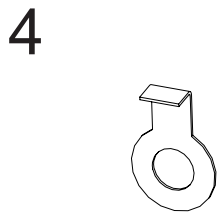

8x 88-218

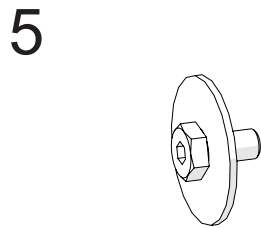

4x B-710612

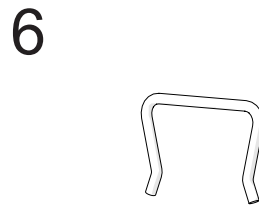

3x 01-528

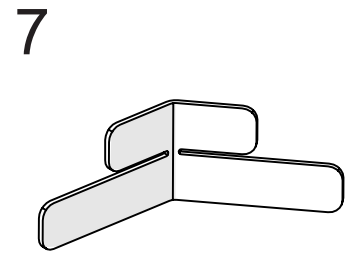

2x 01-206

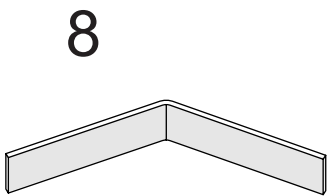

2x 01-208

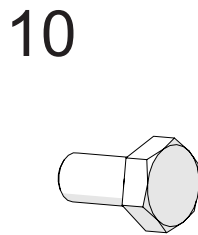

4x B-370612

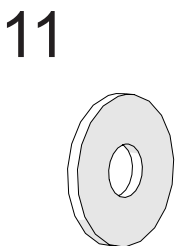

4x B-020008

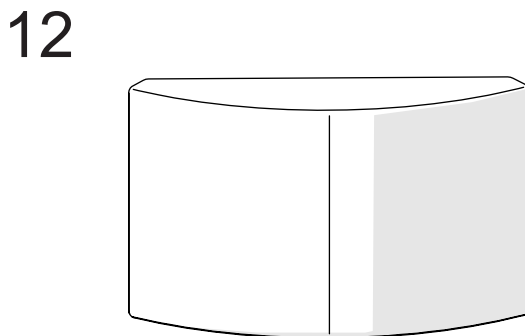

2x 88-506

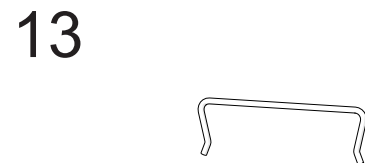

2x 88-308

14

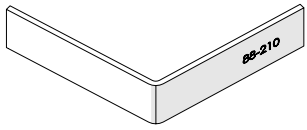

1x 88-210

15

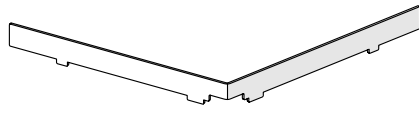

1x 88-212

16

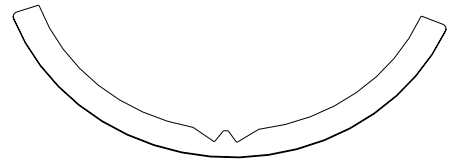

1x 88-200

17

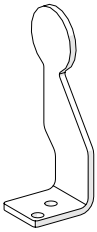

1x 88-124

18

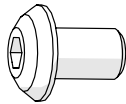

2x B-360508

19

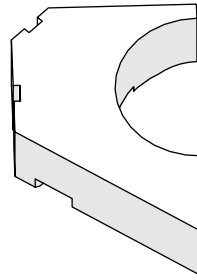

2x 88-408

20

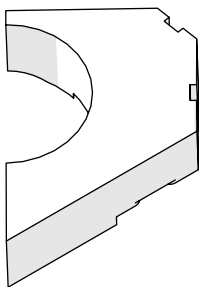

2x 88-404

21

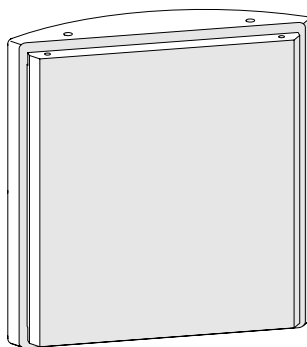

2x 88-504

22

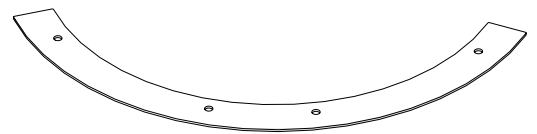

1x 88-202

23

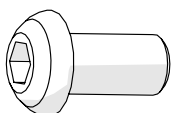

4x B-360616

24

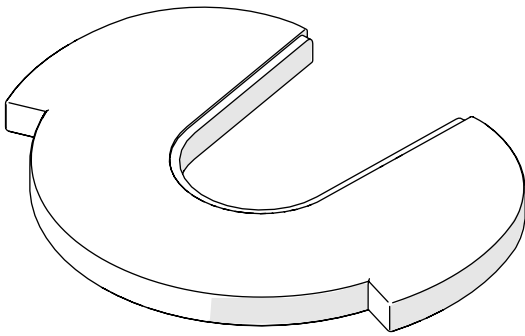

1x 88-515

25

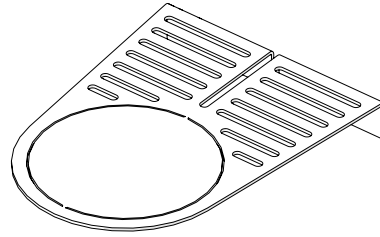

1x 88-0009

26



4x B-330806

27



12x B-427524

28



12x B-330504

29

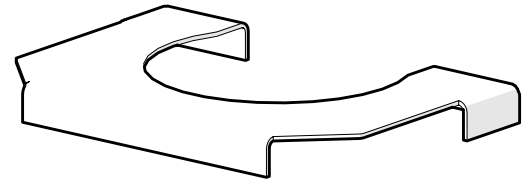

1x 86-0048

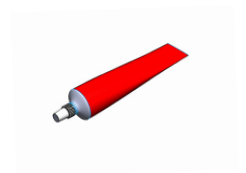

+



